



MASH 2016

TL4 CABLE BARRIER SYSTEM

INSTALLATION GUIDE

**Gibraltar Cable Barrier System
1208 Houston Clinton Dr.
Burnet, Texas 78611**

+1 (512) 715-0808 ● www.gibraltarglobal.com

[Note to Installer: Refer to Contract Plans and Documents for Specific Details]

The Gibraltar Cable Barrier Systems are covered by one or more of the following patents:
U.S. Patent No(s): 7,364,137; 7,398,960; and 7,401,996. Other U.S. and International patents are pending

Version [7.0]

Updated: [September 2020]



INSTALLATION GUIDE

TABLE OF CONTENTS

3

I WELCOME

II. SYSTEM COMPONENTS

III. EQUIPMENT / TOOLS REQUIRED

4

IV. TERMINAL SECTION INSTALLATION

9- 13

V. LONGITUDINAL SECTION
INSTALLATION

A. Socketed System

B. Installing Cable

C. Installing Hairpins and Lockplates

D. Installing Cable Splice Turnbuckles

15

VI. REPAIRS & MAINTENANCE

16

VII. TECHNICAL & SALES SUPPORT



I. Welcome

Welcome to the Gibraltar Cable Barrier System Installation and Maintenance Guide. This guide is for your use when installing Gibraltar's cable barrier system. This installation guide is for standard cable barrier installations.

Before You Begin:

Check and confirm packing list contents. Please report any errors or shortages immediately to Gibraltar at 1 (833) 715-0810 or 512-715-0808.

II. System Installation & Components

- A. Cable Barrier System – Longitudinal Section Layout
- B. Cable Barrier System – Terminal Section Layout
- C. Cable Interchanging
- D. Parts Lists

III. Equipment/Tools Required

- IV. Auger (for Socketed Line Post and Terminal Post foundations)
- V. Auger (Anchor Post foundation)
- VI. Post Driver (for Driven Post option)
- VII. Adjustable Wrench (2)
- VIII. Tension Meter
- IX. Utility Trailer (rigged for Wire Rope Spools)
- X. Flathead Screwdrivers (2)
- XI. 3 Ton (6000 lb.) Chain Hoist (6 Ton hoist may be required in cold climates)
- XII. Cable Grabbers (2)
- XIII. Vice Grips (large enough to fit over 3/4in cable) or 3/4in cable clamps
- XIV. Thermometer

IV. Terminal Section Installation

The Gibraltar cable barrier system shall be installed in standard compacted soil. Soil must be well drained.

Step 1. Establish and verify starting point of cable barrier system in cooperation with designated Transportation Department representative. If the starting point is at the beginning of the length of need/longitudinal section and not the terminal section, then add 27ft-6in to the starting point.

Step 2. Establish the cable barrier center line. Mark the position/s of the Anchor Post/s (Part AP-MASH-4CBL) and terminal posts as per manufacturer's plans.

NOTE: when excavating, each hole is offset 2in from the center line, on alternating sides of the cable barrier fence line.

Long side of Socket

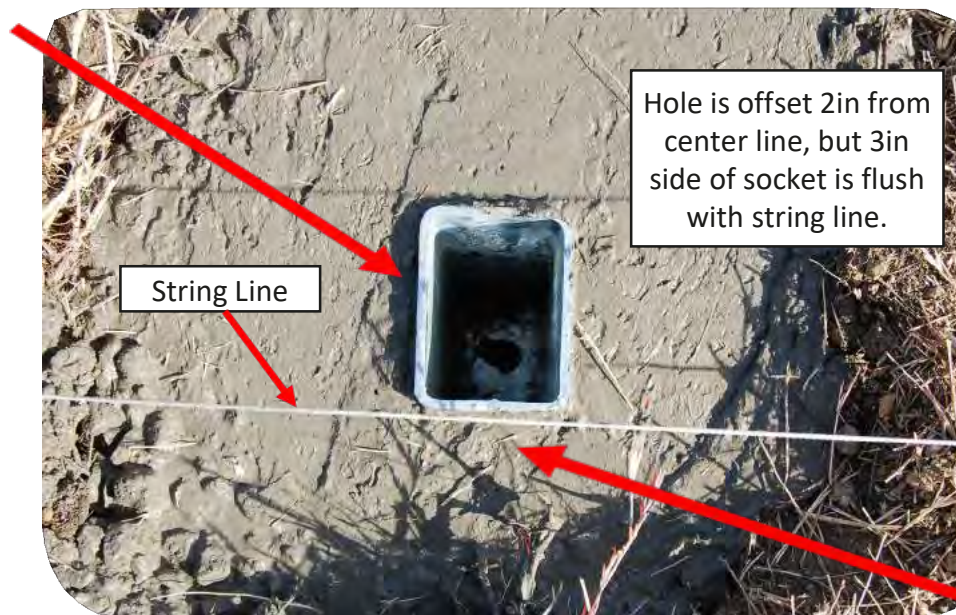

Short Side of Socket

Place Socket in terminal post holes. Place the 3in (short) side of the socket directly on the string line, parallel to the cable barrier center line.

Note: Some sockets have a welded seam along the inside of the 3in side of the socket.

NOTE: In terminal posthole No. 1, the socket must be angled toward the anchor 1¼in in 12in out of plumb.

Post out of plumb tolerance: The sockets should be set plumb, or the posts driven plumb. An acceptable tolerance out of plumb is 3in at the top of the post. This tolerance is aesthetic only and does not affect the performance of the system.

Version: [7.0]

Updated: [Sept 2020]

Step 3. Center and auger the 24in diameter by 10ft minimum deep hole for the embedded Anchor Post (Part AP-MASH-4CBL). Hole must be in-line with the cable barrier center line.

NOTE: Sizes of footings may vary depending upon state specifications and soil conditions.

Step 4. Place anchor post rebar cage (provided by installer) into the hole and pour concrete to within 2ft of top, then stab Anchor Post (Part AP-MASH-4CBL) in place plumb. Finish pouring concrete to grade. The center of the Anchor Post should be centered in the hole and set in-line with the cable barrier string line.

NOTE: The center of the Anchor Post must be centered in-line with the cable barrier center line.

Set the lowest edge of the top plate of the Anchor Post one inch (1in) above grade facing opposite from the cable barrier system.

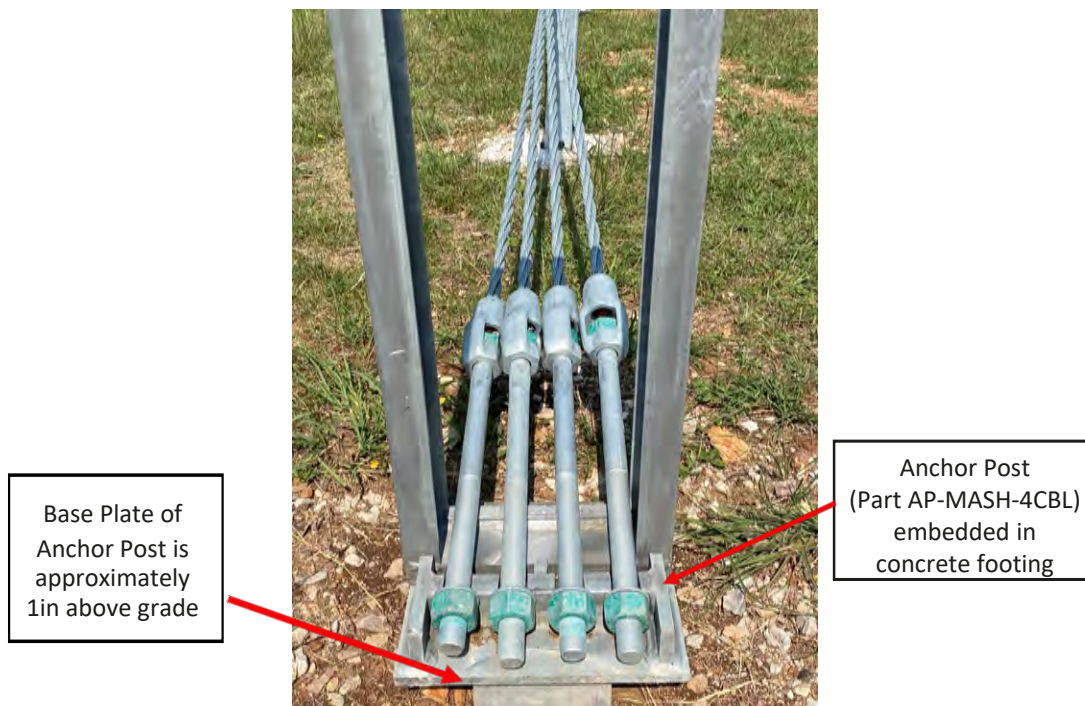

NOTE: The Gibraltar terminal is designed for standard soil special depths and anchor designs are used for alternative soil types. The soil should be well drained and compacted. If poor soil conditions are encountered it is important that you contact your transportation agency for any special criteria for weak soil conditions. In some cases it may require that a qualified engineer be consulted for soil investigation and engineering.

Allow concrete to set for a minimum of 72 hours before tensioning cables.

Set the socket for Terminal Post No. 1 (Part TP1-4) angled towards Anchor Post 1½in in 12in out of plumb.



The angle of the socket for Terminal Post No. 1 (Part TP1-4) may be determined by tilting the socket 1½in in 12in out of plumb, or 5/8in in 6in out of plumb. Add specified concrete.

Step 5. Place Terminal Post TP1-4 and Terminal Post TP4-4, in their respective sockets. For each Terminal Post, place the “open” side of the C-Section post away from the center line. Place the three (3) or four (4) J-Bolts (Part J-BLT) as required in each terminal post.

4 J-Bolts
(Part TP1-4)



3 J-Bolts
(Part TP4-4)



Set Cable Release Post (Part CRP-MASH-4CBL) on top of Anchor Post (Part AP-MASH-4CBL).



Top Section is
Cable Release Post
(Part CRP-MASH-4CBL)

Anchor Terminal
Fitting with Cable End
(Part ATF-END)

Bottom Section is
Anchor Post
(Part AP-MASH-CBL)

“Acorn” shaped
casting



Cable Release Post
(Part CRP-MASH-4CBL)

Anchor Terminal
Fittings Cable END
(Part ATF-END)

Step 6. Connect the four (4) cables to the Anchor Terminal Fittings (Part ATF-END) by inserting the cable ends into the “acorn” shaped casting of the Anchor Terminal Fittings (Part ATF-END). Using two flathead screwdrivers, separate the three strands of the cable at the end within the acorn shaped casting.

Place and insert the triangular wedge between the cable strands. The triangular wedge must point toward the cable. The strands will fit within the acorn channels. Remove the screwdrivers and drive the wedge into the cable, at least a 1/2in past the end of the cable. Next, take a hammer and hit the end of the acorn casting away from the cable in order to securely set the cable into the casting. Then place the nut inside the opening of the Anchor Terminal Fitting (Part ATF) and thread onto the bolts. *Refer to video on website for further demonstration. (www.gibraltarglobal.com)

Connect the Anchor Terminal Fittings (Part ATF-END) with cable attached into the Anchor Post.

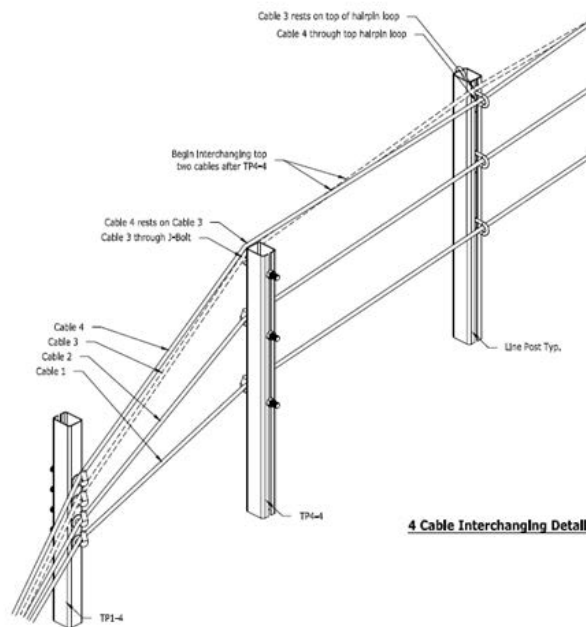
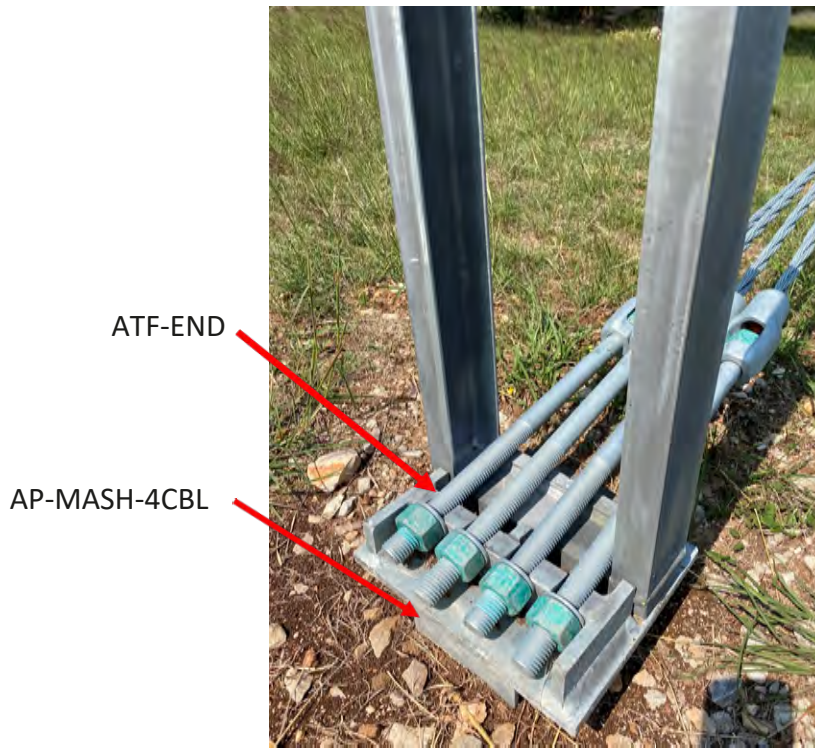

Version: [7.0]
Updated: [Sept 2020]

V. Longitudinal Section Installation

The Gibraltar cable barrier system is to be installed as a median or roadside barrier with a slope of 4:1 or flatter without depressions, obstructions, etc, that may influence or have an effect on vehicle stability or trajectory. Site grading or fill may be required where topographical issues would prevent the cable height to be inconsistent with tested and proper design heights.

The Gibraltar MASH16 TL-4 cable barrier system is acceptable as a TL-3 traffic barrier when placed no farther than 4ft down a 4:1 slope (for adjacent traffic impacts) and no closer than 8ft from the ditch bottom for opposite side impacts.

A. Socketed System

Step 1 - For a socketed system, space the line posts and dig the footings as shown on the plans. Center the auger 2in off the center line, alternating on each side of the center line. All line post sockets should be set plumb.

Rock Clause: Where solid rock is encountered:

- For a socketed post, continue digging hole, 15in deep into rock or to the required plan depth whichever comes first.
- For a driven post, drill a 4in diameter hole 18in deep into rock or to the required plan depth, whichever comes first.
- For an Anchor Post, continue digging hole, 30in deep into rock or to the required plan depth, whichever comes first.

Step 2. Place the appropriate Socket in each hole and set plumb. Place the 3in side of the socket directly on the string line and parallel to the center line of the cable barrier fence.



Step 3. Place the Line Post (4-LNP-S) into socket. Alternate posts with the “open” seam of the C-section post facing the center line.

Version: [7.0]

Updated: [Sept 2020]

B. Installing Cable

For the installation of all systems, we recommend that you utilize a utility trailer with the capacity to spool and dispense all four cables simultaneously. **(NOTE: Each spool contains 2,000 linear feet of cable and weighs approximately 1,900 lbs per spool.)** Special arrangements can be made for more or less cable per spool.

It is preferable to use a cable trailer with a GVW of 20,000 - 24,000 lb. capacity, capable of holding a minimum of six (6) spools of cable at one time. Six (6) spools of cable, along with enough related posts and parts weigh approximately 18,000 lbs.



Special Note: When factory swaged cable is required, call Gibraltar for special instructions on unspooling, stringing and connecting swaged cable.

C. Installing Hairpins (Part 4-HPIN Alum) and Lockplates (Part 4-Lock)

Step 1. Insert the bottom end of the appropriate Hairpin into the C-section channel located at the top of the open line post by holding the angled handle of the hairpin.

Step 2. Lay the three bottom cables in molded/indented slots of the hairpin and place the hairpin on top of the back side of post, then drop the appropriate Lockplate into place on the inside of the line post. Place the fourth cable on top of the hairpin, see Cable Interchanging Drawing below and in Appendix.

Cable Height Tolerances: The bottom cable should be 20in above ground grade, +/- 1in tolerance is allowed, at the socket or post location.

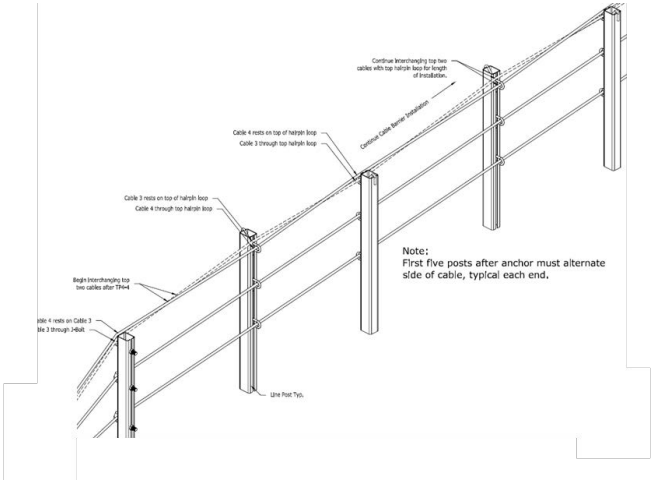

Installed Hairpin and Lockplate

Geometric Features (Depressions)

When the cable barrier installation goes through a depression and tension on the cables begins to pull the hairpin and lockplate up and out of the top of the C-section post, attach the lockplate to the C-section post with a self-tapping set screw (size #12 by 3/4in). Also, if necessary, with a socketed post system, it may be necessary to run a self-tapping screw in between the post and the socket. (See photos below.)

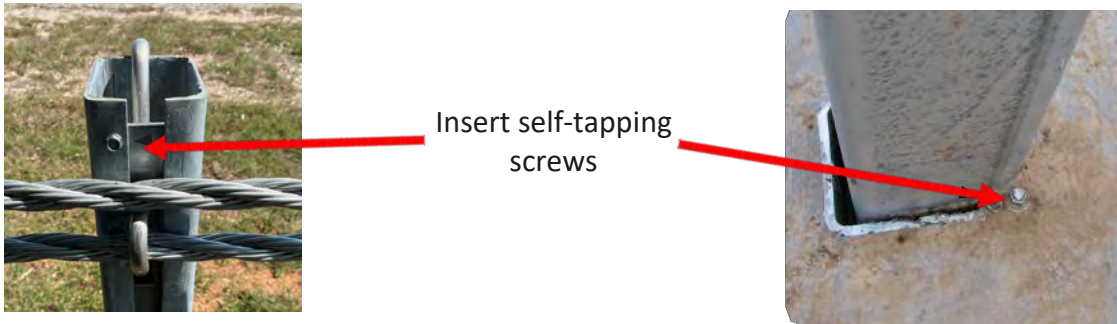

D. Installing Cable Splice Turnbuckles

Step 1. At every 2,000ft (ensure at least one set of turnbuckles per run), cut the cable and place a Cable Splice Turnbuckle (Part CSTB) between the cable sections. Connect the cable to the Cable Splice Turnbuckle (Part CSTB) by inserting the end of the cable into the “acorn” shaped casting of the cable splice turnbuckle.

Step 2. Using two flathead screwdrivers, separate the three strands of cable at the cable ends that go into the acorn shaped casting. Place the triangular wedge spike pointing toward the cable and insert the wedge between the strands. The strands will fit within the acorn channels. Remove the screwdrivers, rotate the acorn up over the wedge and drive the wedge at least a 1/2in past the end of the cable. Take a hammer and hit the end of the acorn casting away from the cable, seating the cable into the casting.

Incorrect Installation of Wedge



Correct Installation of Wedge



Correct Installation of Wedge

Note: When connecting the cable, make sure that all of the turnbuckle bolt threads are available for tightening by the turnbuckles

Version: [7.0]

Updated: [Sept 2020]

Step 3. Place the nut in the opening of the Cable Splice Turnbuckle (Part CSTB) and thread the nut onto the bolt. **NOTE: The Cable Splice Turnbuckle (Part CSTB) should be positioned between line posts, and not directly on a line post.** When cutting the cable, cut just past a line post so that when tension is applied the turnbuckle will be between two posts. If unavoidable, call for additional parts.

Step 4. When connecting cables, use a chain hoist or wench appropriate for the tension needed. If connecting cables in the middle of a run, use two cable jacks and a chain hoist. Tension the cable to the approximate tension shown on the plans, relative to the current temperature at the time of installation.

Step 5. Next, cut and connect the cable by attaching an anchor terminal fitting to the cable, then place all anchor terminal fittings into the slots of the anchor post. (See Step 6, page 7 & 8 for photo detail.) **NOTE: Placement of the anchor terminal fitting (Part ATF) in the anchor Post slots is not a critical placement issue, (for example, the top cable in the middle slot).**

Step 6. When placing final tension on cables (in accordance with the tensioning chart located on the plans) adjust each turnbuckle as needed; log the current date, time, temperature and amount of tension by utilizing the Tension Meter (Part T-MTR).

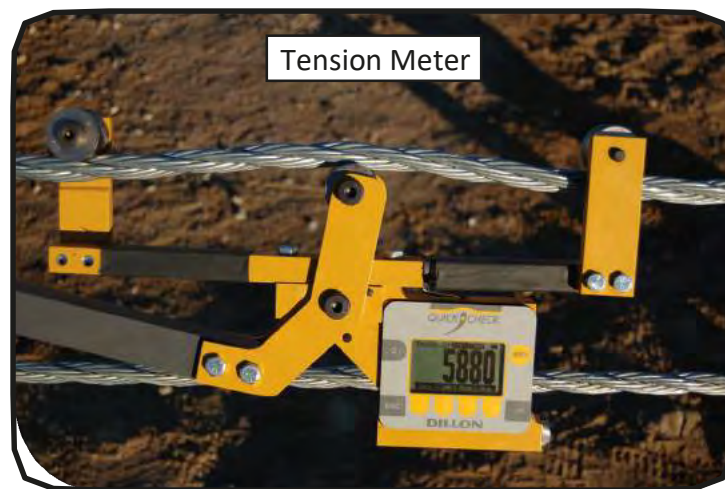

NOTE: Once a section is completed, each section should be checked from beginning to end for correct tension and adjustments, if needed. Once you have reached the specified tension required, take a hammer and screwdriver and “ping” the threads just enough so that the turnbuckle will not “back off”, thus causing a loss of tension.

VI. Repairs and Maintenance

Once the system takes a hit, repairs can be made quickly and easily. Check for any damaged parts within the length of need and/or within the terminal section. All damaged parts must be replaced. The cable can take multiple hits, but when a single strand is broken, cut out the damaged section of cable and splice in a new cable using turnbuckles.

Replacing damaged posts:

To replace a damaged, socketed post when “wedged” in the socket, use a come-along and a straight post as a “pull post” to lift and remove the damaged post out of the socket. Place a new post in the socket. Once all of the damaged posts are replaced, attach the cables with new hairpins and lockplates.

If the terminal section is hit, replace any and all damaged parts and re-install as per terminal section installation instructions.

If a vehicle becomes entangled:

Should a vehicle become entangled in a cable and cannot be removed from the system, as a last resort, the turnbuckle may be cut to untangle the vehicle. Use extreme caution when cutting the turnbuckle. Have all personnel stand clear of the system. Whoever is cutting the turnbuckle should stand perpendicular to the cable and cut with a quick saw. Note that it is important to realize that if you cut the turnbuckle you can cause more damage to the system. Therefore, cutting a turnbuckle should be used only as a last resort and extreme caution should be exercised. See last page in this manual for recommendations.

Re-tensioning cable:

Go to the nearest turnbuckle and attach the tension meter to the first cable you will be tightening. Adjust the turnbuckle until the tension on the cable matches the tension chart, based on the current temperature. Repeat this process for the other two cables.

Note: If the system takes a hit within 300ft of a turnbuckle, adjusting the turnbuckles at that one location should be sufficient. However, if the system takes a hit midway between turnbuckle splices, (approximately 1,000ft from a turnbuckle), re-tensioning should be performed at turnbuckles on each side of the hit.



CONTACT US

WWW.GIBRALTARGLOBAL.COM

VII. TECHNICAL SUPPORT

Gibraltar Cable Barriers
1208 Houston Clinton Dr.
Burnet, TX 78611
833-715-0810 (toll free)
512-715-0808 (office)
512-715-0811 (fax)
info@gibraltarglobal.com

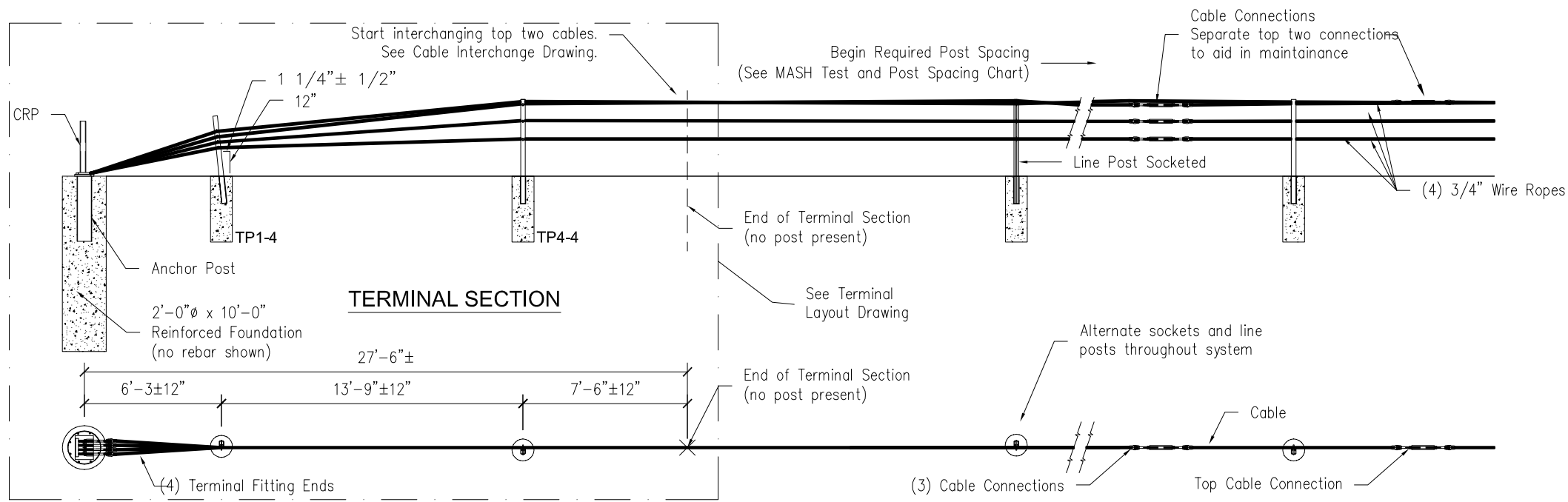

GENERAL NOTES:

- For additional information contact Gibraltar, Inc. at 1-833-715-0810 or see the manufacturer's product manual.
- All concrete shall be per specification; minimum 2500 PSI.
- The Cable Barrier System shall be installed on shoulders or on medians with slopes of 6:1 or flatter. If installed on slopes steeper than 6:1 up to 4:1 the TL-4 system performs as a TL-3 and Gibraltar must be contacted for various guidelines related to placement and post spacing.
- The Gibraltar cable barrier system shall be installed in standard compacted soil. Soil must be well drained.
- See the specification for delineation.
- Rock Clause: Where solid rock is encountered:
 - For socketed post, continue digging 12" diameter, 15" deep into rock or the required plan depth, whichever comes first.
 - For driven post, core drill a 4" diameter hole 18" deep into rock or the required plan depth, whichever comes first.
 - For Anchor post, continue digging 24" diameter, 30" deep into rock or the required plan depth, whichever comes first.
- The Gibraltar cable barrier system shall be installed in standard compacted soil. Soil must be well drained.
- All non-welded rebar by others.
- Line and Terminal Post Foundation Reinforcement Options
 - Without mowstrip, 36" Deep x 12" diameter foundations with #3 rebar ring x 8" diameter with two #4 rebar vertical bars 30" long or 30" welded rebar socket.
 - With 4" minimum depth hot mix asphalt, 30" deep x 12" diameter foundations with #3 rebar ring x 8" diameter with two #4 rebar vertical bars 30" long or 30" welded rebar socket.
 - With 3" minimum depth concrete mowstrip, 24" deep x 12" diameter foundations. (No rebar required) .

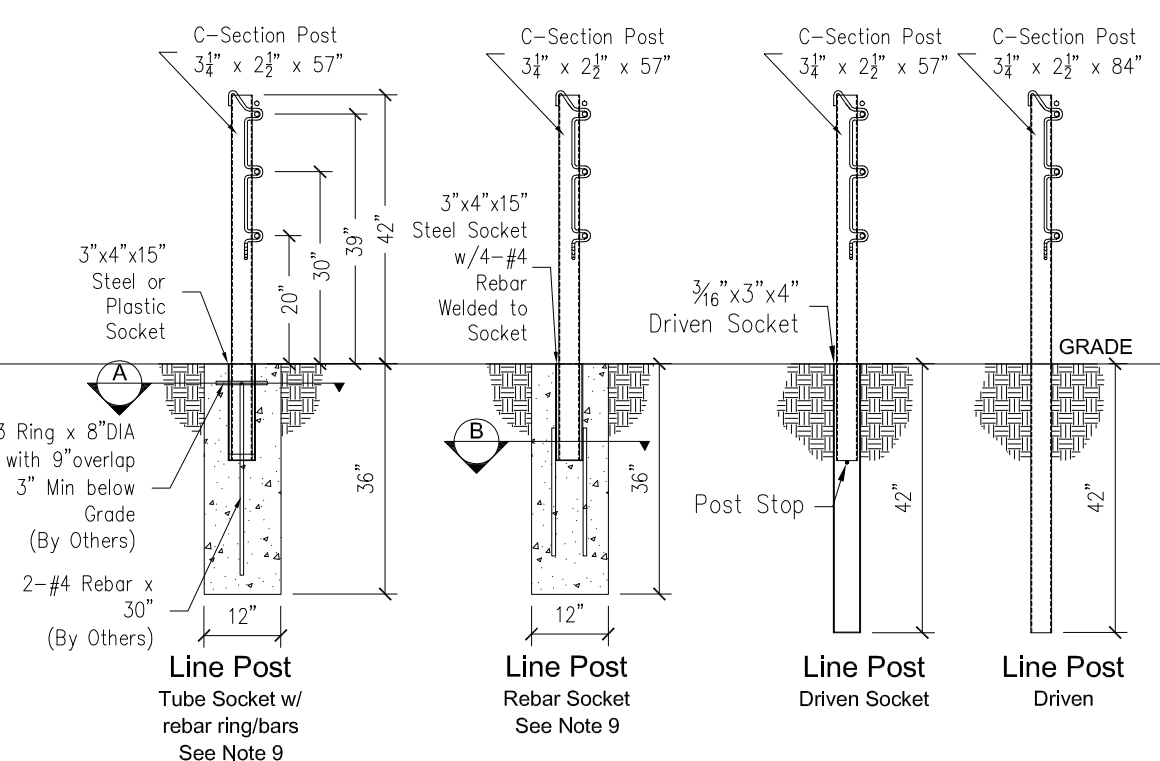
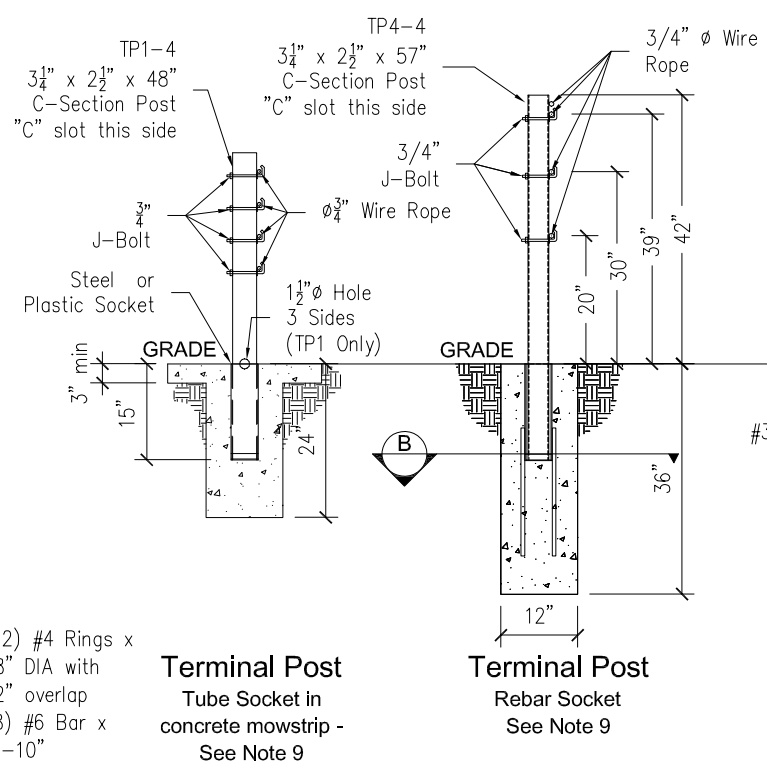
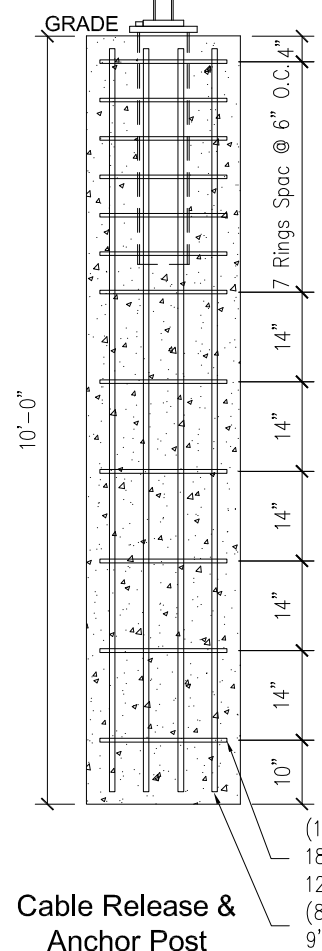
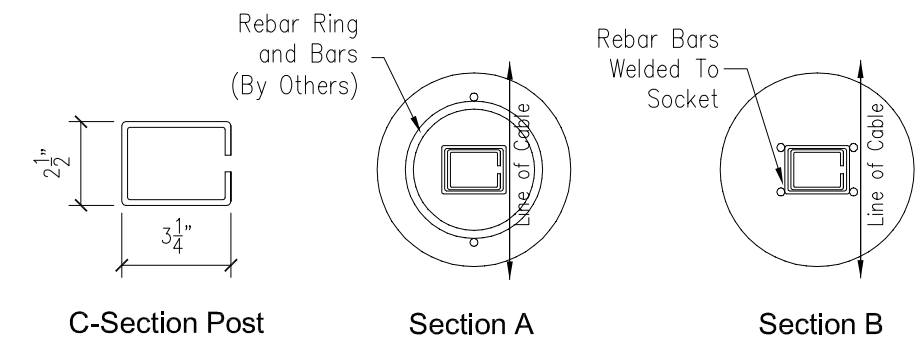
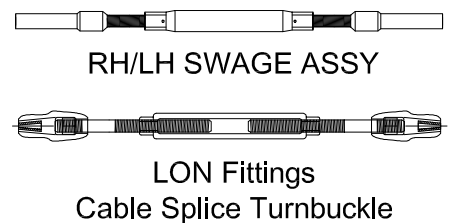
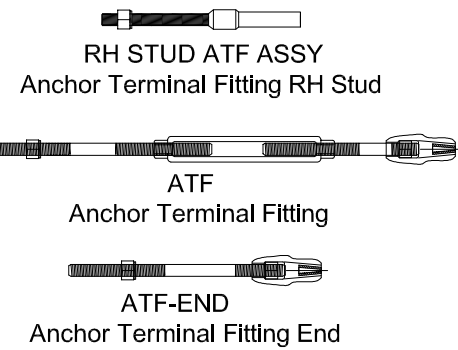

MASH 2016 TL4 Post Spacing Chart

MASH TEST	Line Post Spacing
3-10	7'-0"
3-11	7'-0"
3-11	21'-0"
4-12	21'-0"

Cable Tension Chart*

-10 °F	8600
0 °F	8200
10 °F	7800
20 °F	7400
30 °F	7000
40 °F	6600
50 °F	6200
60 °F	5800
70 °F	5400
80 °F	5000
90 °F	4600
100 °F	4200
110 °F	3800

*±6" post spacing tolerance *Allowable Deviation from Chart +/- 10%

PROPRIETARY TO GIBRALTAR

MASH 2016 TL4 Cable System Layout

Gibraltar Cable Barrier Systems

Scale: **NTS** Date: **1-7-2019**

Layout: **ANSI B** Drafter: **BH**

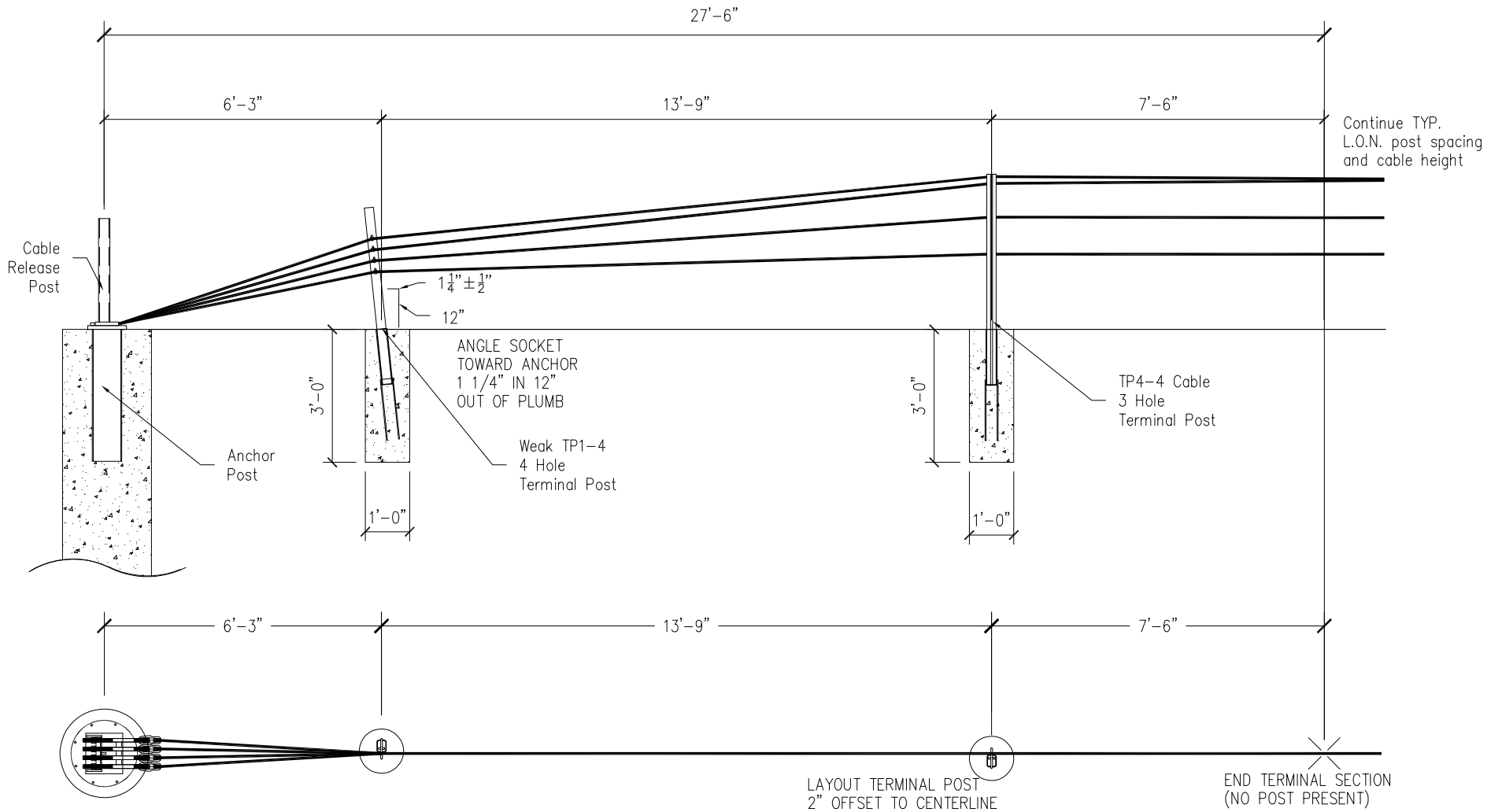

PROPRIETARY TO GIBRALTAR

	MASH 2016 TL3	
	Mash Terminal Layout	
	Gibraltar Cable Barrier Systems	
	Scale: NTS	Date: 1-7-19
Layout: ANSI B	Drafter: BH	

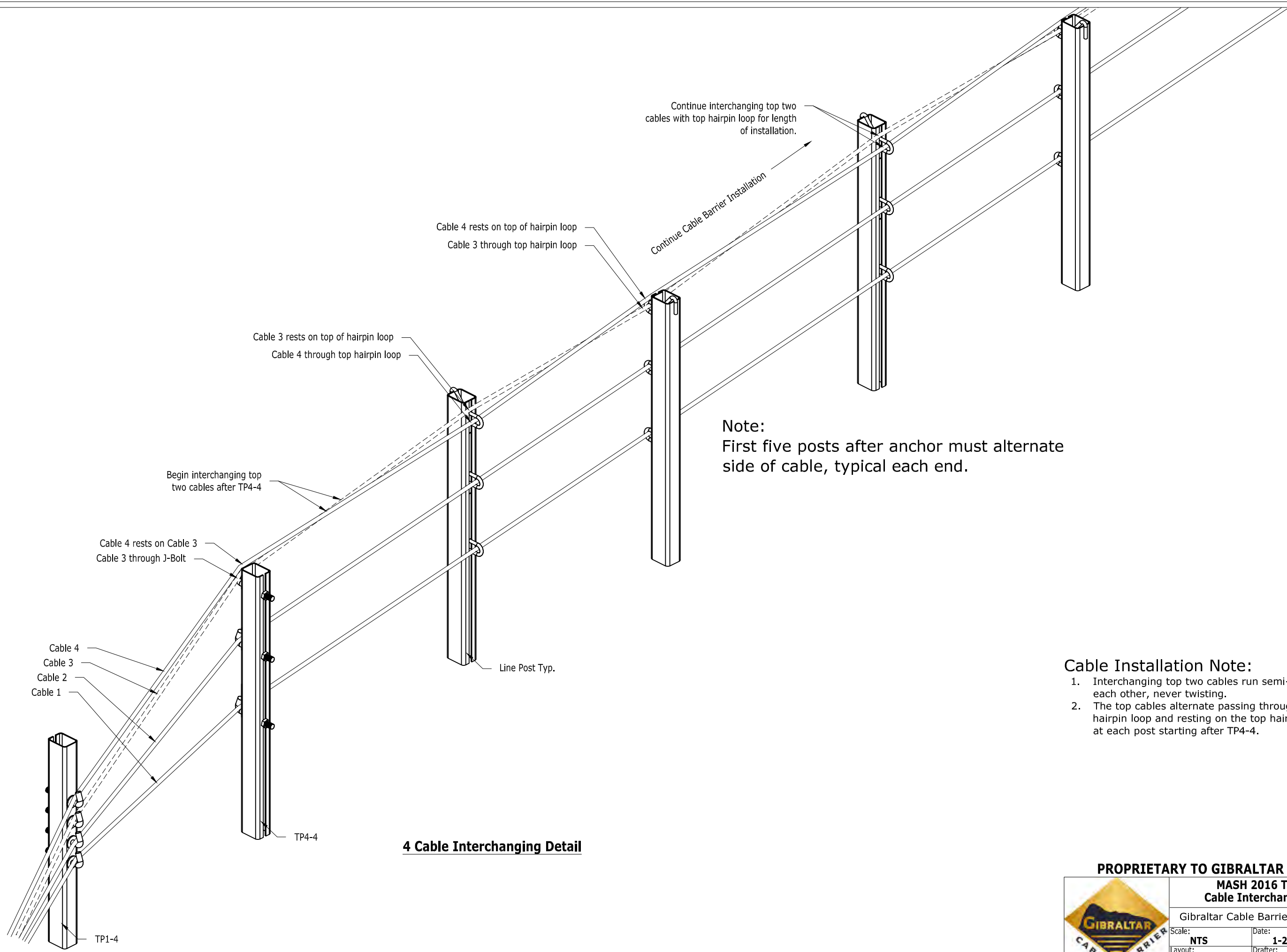

Note:
 First five posts after anchor must alternate side of cable, typical each end.

- Cable Installation Note:**
1. Interchanging top two cables run semi-parallel to each other, never twisting.
 2. The top cables alternate passing through the top hairpin loop and resting on the top hairpin loop at each post starting after TP4-4.

4 Cable Interchanging Detail

PROPRIETARY TO GIBRALTAR



MASH 2016 TL4 Cable Interchanging	
Gibraltar Cable Barrier Systems	
Scale: NTS	Date: 1-2-19
Layout: ANSI B	Drafter: JP

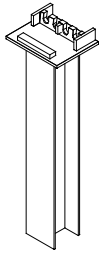

AP-MASH-4CBL
MASH Anchor Post

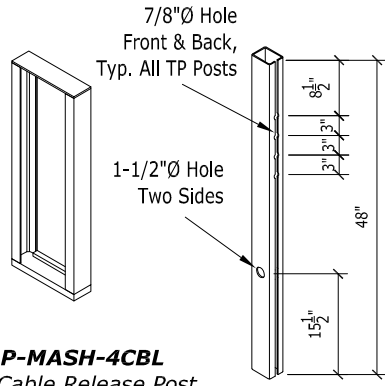

CRP-MASH-4CBL
MASH Cable Release Post

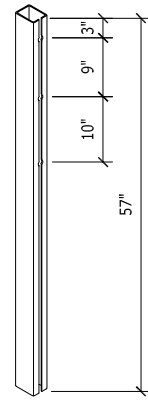

TP4-4
Terminal Post

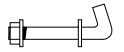

J-BLT
J-Bolt



RH STUD ATF ASSY
Anchor Terminal Fitting RH Stud

TP1-4
Terminal Post
No. 1/Weak



ATF
Anchor Terminal Fitting



ATF-END
Anchor Terminal Fitting End

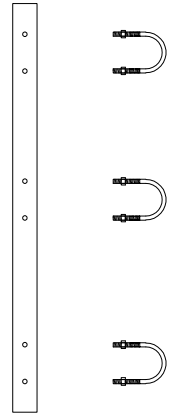

U-Bolt Lock-Plate Assembly

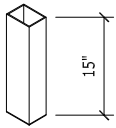

Tube Socket
(Steel or Plastic)

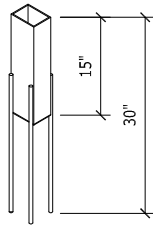

SOCK-S
Short Rebar Socket

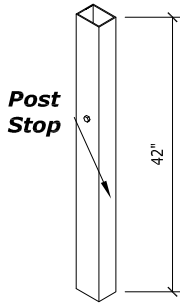

TUBE-D
Driven Socket

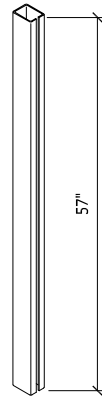

4-LNP-S
Line Post/Socketed

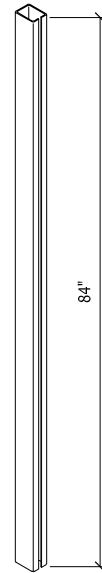

4-LNP-D
Line Post/Driven



4-HPIN Alum.
3 Cable Alum. HPIN

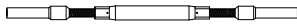

RH/LH SWAGE ASSY



CSTB
Cable Splice Turnbuckle



WEDGE



ACORN
Acorn w/ Wedge



TORP
Longitudinal Section ONLY
Torpedo Cable Splice

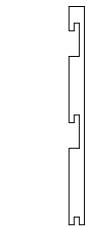

4-LOCK
TL4 Lockplate

PROPRIETARY TO GIBRALTAR



MASH 2016 TL4 System Parts

Gibraltar Cable Barrier Systems	
Scale: NTS	Date: 12/19/18
Layout: ANSI B	Drafter: BH



ORDER FORM COVERSHEET

1208 Houston Clinton Dr., Burnet, Texas 78611
(512) 715-0808 | Toll-Free: (833) 715-0810 | Fax: (512) 715-0811

ORDERS@GIBALTARGLOBAL.COM

ALL ORDERS MUST HAVE A COMPLETED COVER SHEET TO PROCESS WITHOUT ANY DELAYS
****PLEASE ALLOW 3-5 BUSINESS DAYS TO PROCESS ORDERS PLUS SHIPPING/TRANSIT TIME ****

DATE:	PLEASE CHECK ALL APPLICABLE BOXES	QUOTE NEEDED FOR:	MATERIALS	FREIGHT
COMPANY NAME:				
CONTACT NAME:				
PHONE NUMBER:				
FAX NUMBER:				
EMAIL:				

* PLEASE INCLUDE YOUR EMAIL ADDRESS SO WE CAN SEND YOU AN ORDER CONFIRMATION FOR APPROVAL PRIOR TO SHIPPING (BE SURE YOUR EMAIL ADDRESS IS LEGIBLE)

PO NUMBER:	COUNTY & STATE:
-------------------	----------------------------

SHIPPING ADDRESS:	BILLING ADDRESS:

SHIPPING CONTACT:		RECEIVING HOURS:	
SHIPPING PHONE:		RECEIVING HOURS:	

*** PLEASE LIST ANY SPECIAL DELIVERY NEEDS BELOW ie. CALL AHEAD REQUIREMENTS, LIFT GATE REQUIRED, LIMITED ACCESS, ETC.***

Notes:

FOR QUESTIONS REGARDING ORDERS PLEASE CONTACT JOHN JANSEN AT (512) 715-0808. JJANSEN@GIBALTARGLOBAL.COM

FOR TECHNICAL QUESTIONS CONTACT INFO@GIBALTARGLOBAL.COM

****PRICES DO NOT INCLUDE SHIPPING & HANDLING CHARGES ****

****PLEASE NOTE IF FREIGHT COSTS NEED TO BE INCLUDED IN THE PRICE OF MATERIALS ****

Version: [7.0]
Updated: [Sept 2020]



SYSTEM TYPE: MASH16 TL4

TO ORDER REPLACEMENT PARTS, CONTACT:

Gibraltar Global LLC
1208 Houston Clinton DR
Burnet, TX 78611

Toll Free: (833) 715-0810 Office: (512) 715-0808
Email: ORDERS@gibraltarglobal.com Fax: (512) 715-0810

PART #	ITEM / DESCRIPTION	PRICE	UNIT	QUANTITY	EXTENDED AMT
4-HPIN ALUM	3 Cable Alum HPIN		EA		
4-LOCK	TL-4 Lockplate		EA		
U-LOCK	U-Bolt Lockplate Assembly (Consists of Lockplate and 3 U-bits)		SET		
4-LNP-S	TL-4 Line Post / Socketed (57")		EA		
4-LNP-D	TL-4 Line Post / Driven (84")		EA		
AP-MASH-4CBL	MASH Anchor Post		EA		
SOCK-S	15" Socket 4" x 3" - 15" long w/ (4) 16" bars		EA		
SOCK-P	4x3x15" Plastic Socket		EA		
TUBE-PL	15" Tube Socket 15" 4" x 3" with welded plate		EA		
TUBE-D	42" Driven Socket 4" x 3" with Post Stop at 15"		EA		
CRP-MASH-4CBL	MASH Cable Release Post		EA		
TKW	Terminal Keeper Wire (12-Ga.x 12" long)		EA		
TP1-4	Terminal Post No.1/ Weak 48" (4-Hole)		EA		
TP4-4	Terminal Post No.4/ Standard 57" (3-Hole)		EA		
J-BLT	J-Bolt (3/4")		EA		
ATF-1"	Anchor Terminal Fitting (1") Includes Turnbuckle		EA		
ATF-End 1"	Anchor Terminal Fitting End 1 18" x 1" Rod and Acorn		EA		
CSTB-1"	Cable Splice Turnbuckle (3/4") Open Body		EA		
TORP	"Torpedo" Splice		EA		
ACORN	Acorn		EA		
WEDGE	Wedge For Acorn		EA		
DLN	Delineator / Reflective Object Marker - <i>Specify Yellow or White</i>		EA		
CBL-PRE	Pre-stretched Cable (3/4"Guardrail Cable)*[See Note 1]		LF		
EXCL-CAP	Excluder Cap - Post Base		EA		
CAP	Post Cap Sleeve - Post Top		EA		
T-MTR	Tension Meter with Case *[See Note 2]		EA		
PPE	NOW OFFERING PERSONAL PROTECTION EQUIPMENT	Call for details			
TRAINING	Installation and Repair Training *[See Note 3]	Call for details			
NOTE-1	Cable sold as a complete 2000' spool only (unless remnant pieces are available)	PARTS TOTAL			
NOTE-2	Gibraltar Global recommends that the tension of the cables be checked after every repair	SHIPPING & HANDLING			
NOTE-3	We recommend that ALL contractors installing or repairing our systems be trained and certified by Gibraltar Global * Please call for more information	ORDER TOTAL			



Best Practices to Remove Vehicles from the Cable Barrier System

- Use caution and best judgment when approaching a hit where the vehicle is still engaged with the cables, there could be an unstable situation with the cable.
- Keep “non emergency” personnel away from the cable system
- Methods to release tension in the system
 - If not deeply entangled, go upstream and downstream of the accident for 75’ to 100’ removing lock plates and hairpins to release cables (cables are not attached to the posts) until the weight of the cable overcomes the tension introducing some additional slack and eventually allowing the cables to lie on the ground.
 - Go to the anchor unit and release the tension by pushing over the Cable Release Post with a vehicle bumper, making sure all personnel stand clear of the anchor section.
 - Go upstream or downstream to the nearest cable splice turnbuckle, which are spaced approximately 1000 ft. apart and loosen them a few turns. You will need two crescent wrenches and a long screwdriver/long bar, the longer the wrench the better the leverage.
- Methods to release the vehicle
 - If a vehicle is “entangled” in the cables, first pull the vehicle back towards the centerline of the cable barrier to take out the lateral force of the cable, and then pull the vehicle out the same way it entered.
 - A tow truck should be able to lift most vehicles off the cables if the vehicle happens to end up “straddling” a cable.
- **Only cut a turnbuckle body or cable if it is a life or death situation and the car needs to be removed immediately.**
 - Ask all on-lookers and non-essential personnel to stand clear of the system to prevent injuries from backlash when cutting. Because of the cable’s weight (1 pound/ft), the cable should fall down as it retracts.
 - Ensure that no one is holding the cables near a post as their hand could be pinched upon cutting the cable.
 - Cut the turnbuckle body or cable in between two line posts, 250 to 300 feet away from the vehicle and perpendicular to the cable system.

*** Knocking over the Cable Release Post or cutting a turnbuckle/cable will cause the entire system, from anchor to anchor, to be disabled. Until the system is repaired, the system will lose **all** of its effectiveness to prevent any future accidents and it may allow the next vehicle to get through the system and into oncoming traffic. ***

If you have any questions about the system during an accident, contact Gibraltar Cable Barrier Systems at 833-715-0810 and ask for Jay Winn, Bryan Hoefling or Ron Faulkenberry.

Version: [7.0]

Updated: [Sept 2020]