

AP
Anchor Post

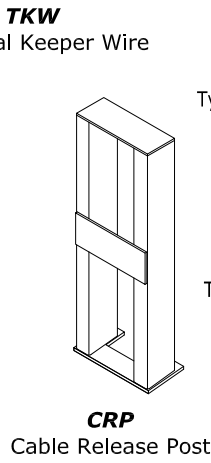

CRP
Cable Release Post

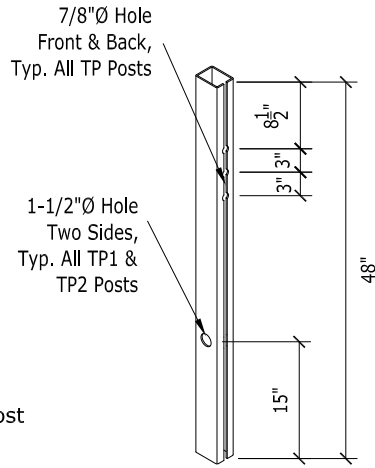

TP1
Terminal Post
No. 1/Weak

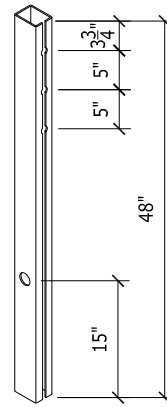

TP2
Terminal Post
No. 2/Weak

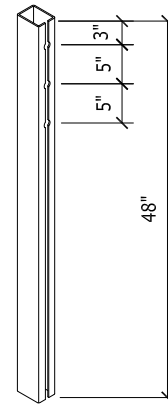

TP3/4-3
Terminal Post

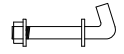

J-BLT
J-Bolt

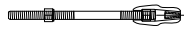

ATF-END
Terminal Section Only
Anchor Terminal Fitting End



ATF
Terminal Section ONLY
Anchor Terminal Fitting

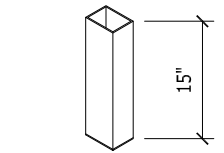

TUBE-PL
Tube Socket w/Plate

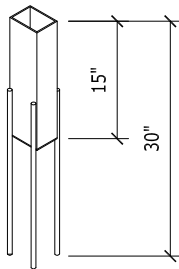

SOCK-S
Short Rebar Socket

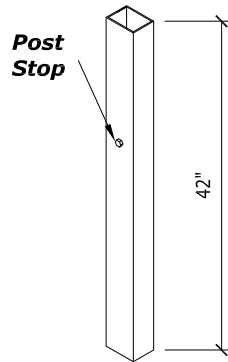

TUBE-D
Driven Socket

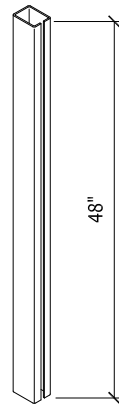

3-LNP-S
Line Post/Socketed

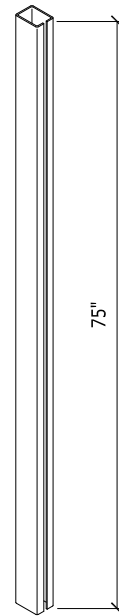

3-LNP-D
Line Post/Driven

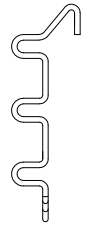

3-HPIN
TL3 Hairpin



3-LOCK
TL3 Lockplate



CSTB
LON Only (Open Body Shown)
Cable Splice Turnbuckle

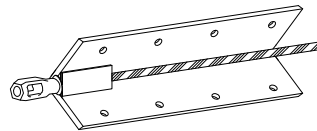

GR-CCB
Terminal Section ONLY
Guardrail Bracket



WEDGE
W-1 Wedge



ACORN
Acorn w/ Wedge



TORP
Longitudinal Section ONLY
Torpedo Cable Splice

PROPRIETARY TO GIBRALTAR



TL3 System Parts

Gibraltar Cable Barrier Systems	
Scale:	Date:
NTS	10-18-17
Layout:	Drafter:
ANSI B	BH